

# JVC

HD Memory Card Camera Recorder

# JY-HM360E

Weddings Are The Beginning



## ProHD



Shown with optional microphone.



## Quality and Performance Worth Celebrating

JY-HM360 was created to capture life's precious events with the quality they deserve. Its light and ergonomic form offers excellent maneuverability, yet it's packed with versatile features to help you concentrate on the client's special day.

### High-performance CMOS Sensor Combined with F1.2 Lens for High-sensitivity Shooting



At the heart of the JY-HM360 is a 1/2.3-inch 18.9 M pixel back-illuminated CMOS sensor, which offers high resolution recordings. When combined with JVC's Dynamic 19x F1.2 Bright GT Lens, brilliant results with excellent sensitivity and less noise can be achieved even in low light environments. This way you can record events, social functions, or weddings without the need for additional lighting.



### Supports an Array of Popular Codecs and File Formats

Featuring JVC's original high-speed picture processing FALCONBRID™ engine, the camera is capable of supporting major file formats such as .MOV with Apple Final Cut Pro™, .MP4 of XDCAM EX™ cameras, and .MTS for AVCHD compatibility, as well as high-definition images in MPEG-2 35Mbps and AVCHD 28Mbps (Progressive) format. Furthermore, the processor also supports H.264 video format in 50Mbps extreme high quality (XHQ) mode for virtually no block noise and to capture high-speed moving subjects.

Video format	MPEG-2		AVCHD					H.264		
Mode (Bit rate)	HQ (35Mbps)	SP (25Mbps)	Progressive (28Mbps)	HQ (24Mbps)	SP (18Mbps)	LP (9Mbps)	EP (5Mbps)	XHQ (50Mbps)	UHQ (35Mbps)	SD (8Mbps)
File format	MOV/MP4		MTS					MOV		
Audio format	Linear PCM 2ch		AC3 2ch					Linear PCM 2ch		
HD	1920 x 1080	60i/50i	60p/50p	60i/50i	60i/50i			60p/60i/50p/50i	60i/50i	
	1440 x 1080	60i/50i	60i/50i				60i/50i			
	1280 x 720	60p/50p								
SD	720 x 576									50i

### Professional Layout, Stylish Design and User-friendly Operations

As a handheld camcorder, the JY-HM360 is ergonomically designed to satisfy discerning videographers. For instance, 3 Rec Trigger button is convenient for any shooting scenes while Zoom Seesaw lever enables smooth zooming from very slow to high speed. The camera also features essential switches and buttons for shooting including white balance, iris, gain, and focus, which are located mainly on the left side panel, enabling intuitive controls to quickly change settings even while shooting. Up to 11 functions can be customized that are assigned to seven user buttons on the camera body and four on the LCD's cross-shaped buttons. For higher level of shooting, image parameters such as gamma and color-matrix as well as other detail settings can be customized and stored in both the camera's internal memory and SDHC/SDXC card.



## Optimum Shooting Mode with Flick of a Switch using Scene Select

As a wedding cameraman, you might use spot lighting to create more dramatic scenes. However, a sudden change in lighting requires quick adjustment of shooting modes. In such instances, the Scene Select function comes in handy as it enables selection of the optimum shooting mode with the flick of a switch. Position A and B in Scene Select can be assigned to specific scenes such as Indoor and Outdoor, both Indoors, or both Outdoors, each of which are assigned with five shooting modes. Using the menu displayed on the LCD and viewfinder. These modes can be set with values. Once set, you simply flick between A and B to achieve the optimum lighting for a scene.



Indoor and Outdoor menus

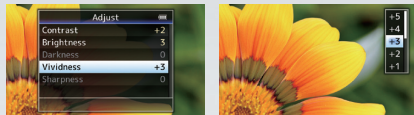

Mode selection menu

Detailed mode adjustment menu

## Scene Select and Shooting Modes

Flick Scene Select A and B to switch between assigned modes



**CONTRAST:** To give contrast (darker or lighter) to subject that appears flat. Settable values between -3 and +3.

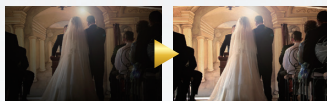

**BRIGHTNESS:** Backlight compensation for auto-iris mode. Settable values are between 0 and 6.

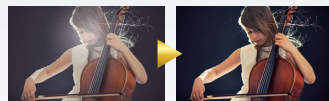

**DARKNESS:** Overexposure compensation. Settable values between 0 and 6.



**VIVIDNESS:** To make the color crisper than how it actually appears. Settable values between -5 and +5.



**SHARPNESS:** For crisper resolution of the subject. Settable values between -3 and +3.

## Beautiful Faces – Essential for Weddings



Made to work at its best in weddings, the JY-HM360 features a number of functions to beautify faces including Face Recognition Auto Focus, Optical Image Stabilizer, and Beautiful Skin mode. Allocated to one of the seven USER customizable buttons, Beautiful Skin mode can be assigned for turning the feature on or off when shooting. When the Beautiful Skin mode is turned on, the feature icon will appear on the LCD and viewfinder.

## Convenient Pre Rec Mode

Enabling Pre Rec Mode, the camcorder continuously buffers up to 15 seconds of video, so that when recording begins the cached video is included in the recorded file, which keeps you from missing a crucial shot because you didn't hit the record button in time.

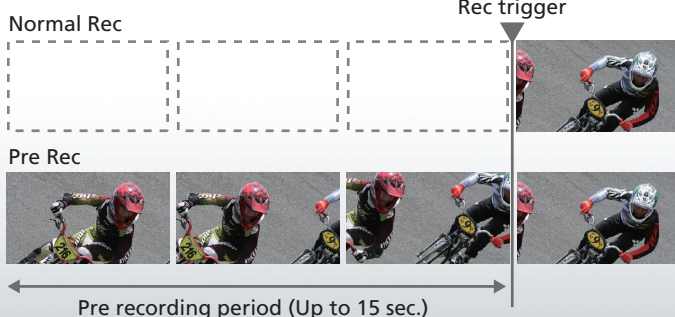

## Clip Continuous Recording – Convenient for File Management and Editing



This function enables you to store a number of shots from rec start to rec stop together as a single clip file. Instead of having to manage enormous amounts of files, or browsing through dozens of separate files just to gather up the scene you need, you can use pre-grouped clips for easier transfer and editing.

## Dual SD Card Slots for Maximum Failsafe Recording

Dual SDHC/SDXC card slots make the JY-HM360 a truly versatile camcorder, offering different recording modes with reliable and cost-effective media. Series (or relay) recording is for making long-hour seamless recording from card A to B and vice versa, Simultaneous (or dual) recording for creating 2 identical cards at same format, and Backup recording for creating 2 different recordings – while the REC trigger is used to REC and STOP recording on one card, the other card can act as a continuous backup that overrides the pause function.

### Series (Relay) Recording



### Dual (Simultaneous) Recording

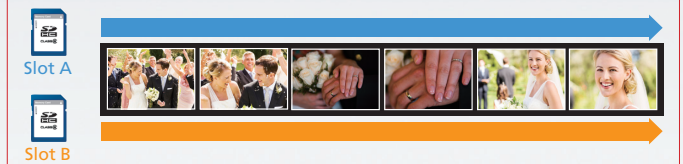

### Backup Recording

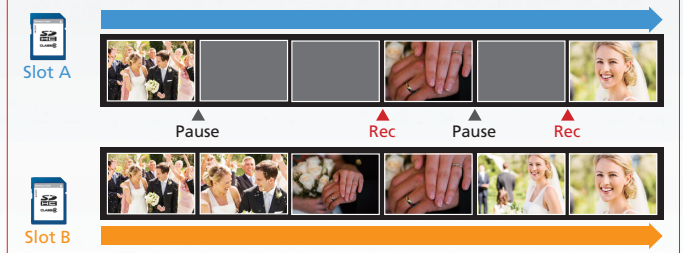

## Just for Professional Utility – Cutting-edge Connectivity including XLR Audio Input

The JY-HM360 offers versatility while meeting the needs of professional applications. For instance, one of the two XLR audio inputs can be used for mic and the other for LINE input of external audio equipment. The list of interfaces featured on the camera includes:



- HDMI out (50p support)
- USB (Device x1)
- TC Sync in/out
- XLR 3-pin x 2 (MIC, +48V <phantom power>, LINE)
- AV out
- Aux in for Wireless Receiver
- ø2.5mm Remote Control
- ø3.5mm Stereo Headphone out

## Other Features

- 0.24-inch 1.56M pixel LCOS Color Viewfinder and 3.5-inch 920K pixel LCD Display
- Auto Focus and other functions to assist shooting
- Mini-jack terminal for Wireless mic receiver or other equipment

## SDHC/SDXC Class 4/6/10 recording time (approx.)

	MOV/MP4			MTS					MOV				
	MPEG-2/HD			AVCHD					H.264/HD				
	HQ	SP	HQ Progressive	HQ	SP	LP	EP	XHQ	UHQ	SD			
	720p/1080i	1080i	1080p	1080i							1008p/i	1080i	576i
4GB	12m	17m	16m	19m	25m	46m	1h 22m	9m	12m	47m			
8GB	25m	35m	33m	38m	50m	1h 35m	2h 48m	18m	25m	1h 35m			
16GB	50m	1h 10m	1h 7m	1h 18m	1h 40m	3h 10m	5h 36m	36m	50m	3h 10m			
32GB	1h 40m	2h 20m	2h 15m	2h 36m	3h 20m	6h 20m	11h 12m	1h 12m	1h 40m	6h 20m			
64GB	3h 20m	4h 40m	4h 30m	5h 12m	6h 40m	12h 40m	22h 24m	2h 25m	3h 20m	12h 40m			
128GB	6h 40m	9h 20m	9h	10h 32m	13h 20m	25h 20m	44h 48m	4h 50m	6h 40m	25h 20m			

Notes: • Recording times are estimate. • Recommended SDHC/SDXC memory card brands: Panasonic, Toshiba, and SanDisk  
• SDHC/SDXC Class 10 card enabled only in XHQ mode. SDHC/SDXC Class 4 card enabled only in AVCHD/SD.

# Specifications

GENERAL SPECIFICATIONS		
Power	DC12V (AC adapter), DC7.4V (Battery)	
Power consumption	Approx. 6 W (with VF in REC mode, default setting )	
Dimensions	177.5 mm (W) x 197 mm (H) x 416 mm (D)	
Weight	approx. 1.7 kg (without battery)	
Operation temperature	0°C to 40°C (32°F to 104°F)	
Storage temperature	-20°C to 50°C ( 14°F to 122°F)	
Operating humidity	30% to 80%	
Storage humidity	under 85%	
CAMERA		
Image sensor	1/2.3" CMOS 18.9M pixels	
Stabilizer	Optical image stabilization with Enhanced Advanced Image Stabilizer	
Lens	F1.2 (wide) to F2.8 (Tele) f= 3.76mm to 37.6mm (f=29.9 mm to 586mm [35mm equivalent; Dynamic Zoom ON])	
Filter diameter	46 mm	
Shutter speed	1/6.25 ~ 1/10000, EEI	
Gain	0, 3, 6, 9, 12, 15, 18,21,24 dB, Lolux (30 dB), AGC	
LCD display	3.5-inch 920 k pixels, 16:9	
Viewfinder	0.24-inch 1.56 M pixel, 16:9	
VIDEO/AUDIO RECORDING		
Recording media	2x SDHC/SDXC memory card (HD: Class 6/10 AVCHD/SD: Class4)	
Video recording	Video codec	MPEG-4 AVC/H.264 (HD/SD), MPEG-2 Long GOP VBR (HD/SD) MPEG-2 Long GOP CBR (HD), AVCHD (HD)
	File format	MOV, MP4, MTS (AVCHD)
	HD (MPEG-2 Long GOP VBR)	HQ mode:1920x1080/59.94i, 50i; 1440x1080/59.94i, 50i; 1280x720/59.94p, 50p; (Max 35Mbps)
	HD (MPEG-2 Long GOP CBR)	SP mode: 1440x1080/59.94i, 50i (25Mbps)
	HD (H.264)	XHQ mode: 1920x1080/59.94p, 59.94i, 50p, 50i (Max 50Mbps)
		UHQ mode: 1920x1080/59.94i, 50i (Max 35Mbps)
	AVCHD	HQ Progressive mode (Max 28Mbps): 1920 x 1080/59.94p, 50p
HQ mode (Max 24Mbps): 1920 x 1080/59.94i, 50i		
SP mode (Max 18Mbps): 1920 x1080/59.94i, 50i		
LP mode (9Mbps): 1440 x 1080/59.94i, 50i		
SD (H.264)	EP mode (5Mbps): 1440 x1080/59.94i, 50i	
	720 x 576/50i (Max 8Mbps) (16:9 / 4:3)	
Audio recording	LPCM 2ch, 48kHz/16-bit (HD/SD, MOV/MP4), Dolby Digital, 2ch (AVCHD)	
INTERFACE		
Video output	AV output (ø3.5mm mini jack x1)	
	HDMI output x1	
Audio input	XLR x2 (MIC,+48V/LINE), ø3.5mm mini jack x1	
Audio output	AV output (ø3.5mm mini jack x1)	
Headphone	ø3.5mm mini jack x1	
Remote	ø2.5mm mini jack x1	
Time code link input/output	RCA x1	
USB	DEVICE x1 (Mass storage)	
PROVIDED ACCESSORIES		
Battery Pack (SSL-JVC50) x1, AC Adapter, Power Cord, Instruction Manual (Basic)		

Optional  
Accessories



**SSL-JVC50**  
Standard Li-ion  
Battery (IDX)  
DC7.4V, 4900mAh,  
37Wh



**SSL-JVC75**  
Long-life Li-ion Battery with  
X-TAP Connector (IDX)  
DC7.4V, 7350mAh, 55Wh



**LC-2J**  
7.4V 2-ch Simultaneous  
Charger (IDX)

## Dimensions

Unit: mm

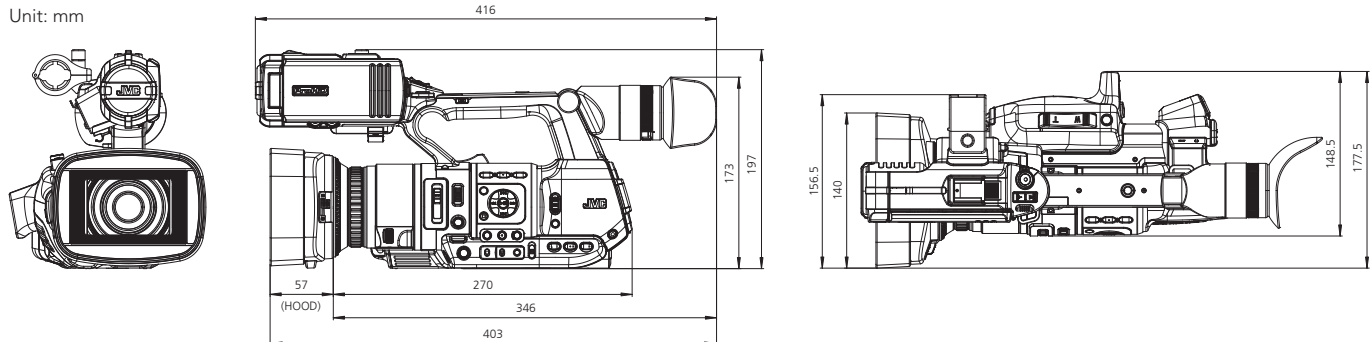

Apple, Apple logo, Macintosh, QuickTime, and Final Cut Pro are trademarks of Apple Inc. registered in the United States and other countries.  
 \*AVCHD Progressive/AVCHD and the "AVCHD Progressive/AVCHD" logo are trademarks of Panasonic Corporation and Sony Corporation.  
 Dolby is a registered trademark of Dolby Laboratories. The SD, SDHC and SDXC logos are trademarks of the SD Card Association. HDMI, the HDMI Logo, and High-Definition Multimedia Interface are trademarks or registered trademarks of HDMI Licensing LLC in the United States and other countries. Product and company names mentioned here are trademarks or registered trademarks of their respective owners.  
 All screen pictures in this brochure are simulated.

*Simulated pictures.*  
 The values for weight and dimensions are approximate.  
 E.&O.E. Design and specifications subject to change without notice.

# JVCKENWOOD

DISTRIBUTED BY